

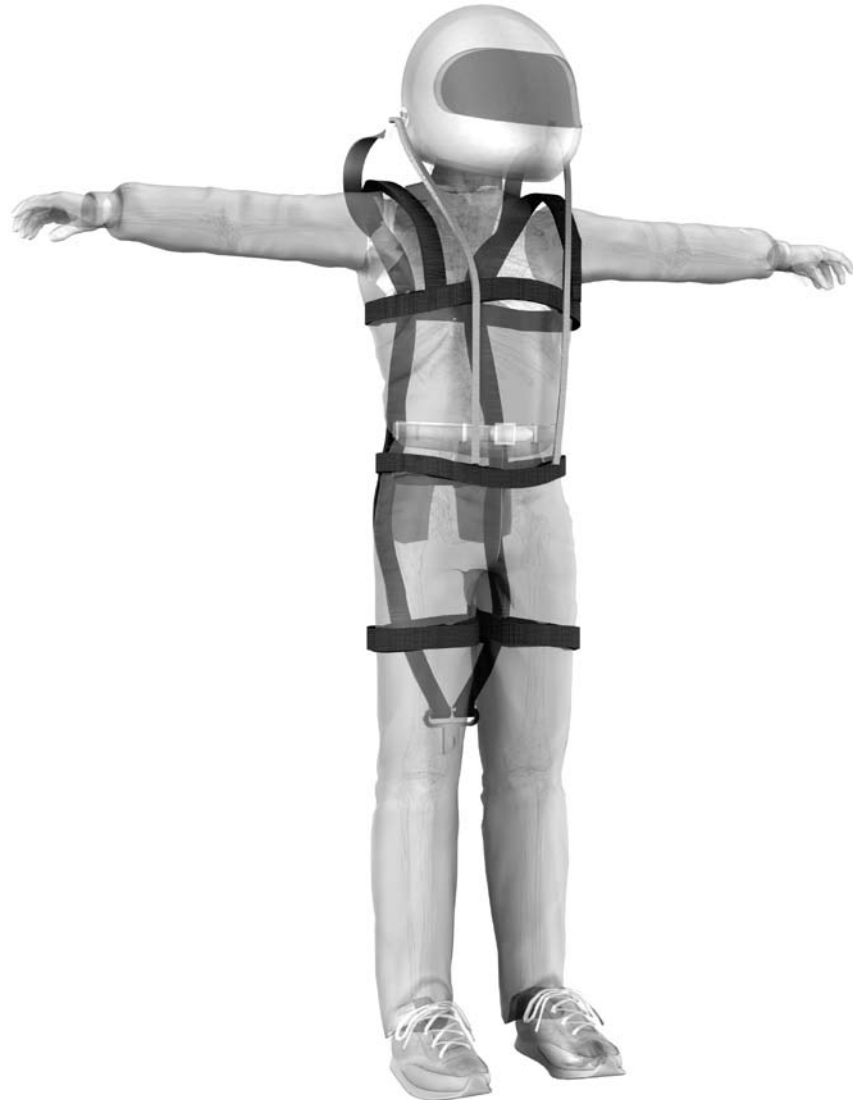

# HUTCHENS DEVICE™



**The products and parts shown herein are to be installed and used in accordance with these instructions. Any deviation by the buyer, installer, or user from these instructions constitutes willful negligence. Products and parts are not to be used if defective, damaged or worn. Products and parts are not to be used after a severe use and, in any event, not after three (3) years from the date of purchase.**

## Installation Manual

**This device not recommended for use with an open face helmet.**

**1**

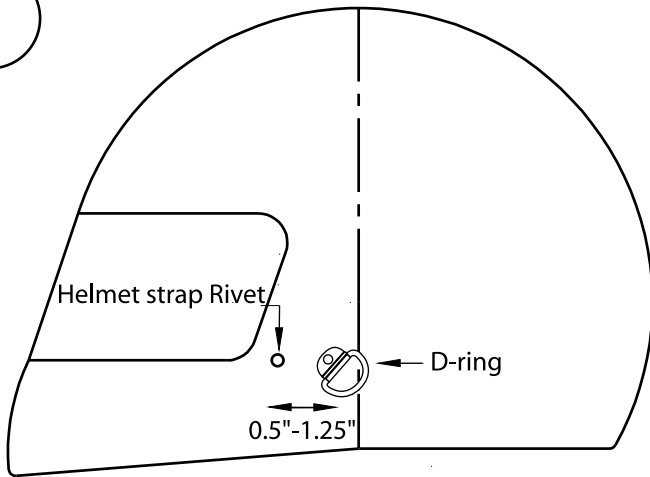

## Single Hook Attachment

Locate helmet hooks symmetrically on both sides of the helmet. The helmet hooks should be located per Figure 1 for a standard helmet and Figure 2 for a sidewinder style helmet.

The hooks need to be located directly in back of the helmet chin strap rivet. Measure straight back from the chin strap rivet .5"-1.25". This should place the mounting screw in front of the hard foam liner.

The helmet hook attachment kit comes with 2 (3/8") screws and 2 (1/2") 10-32 screws. Only TWO screws will be used. The end of the screw should be flush (+/- 1/16") with the inside edge of the Nut/Washer when tightened.

The Nut Washer has been designed to be friendly to the inside of the helmet. Use a medium strength thread locker on the threads of the Nut Washer.

Tighten the helmet hook assembly until snug against the inside of the helmet. Over tightening is not necessary and may damage the helmet shell.

**1B**

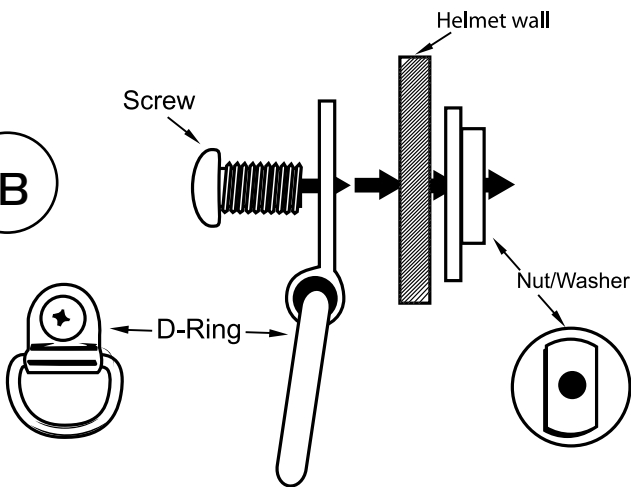

**2**

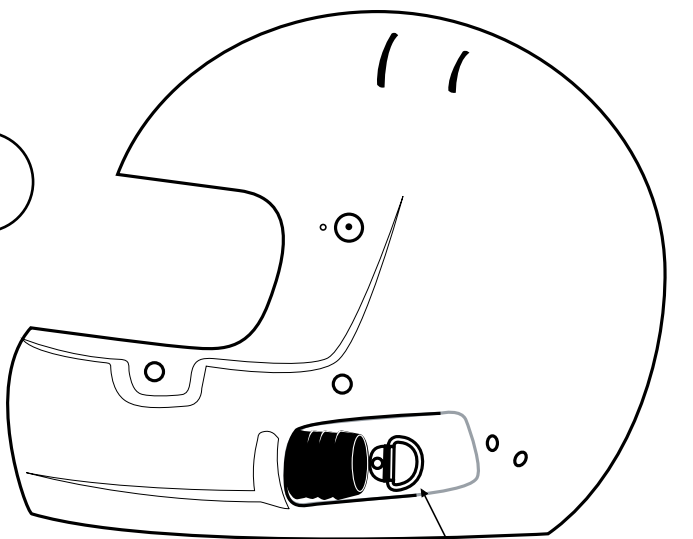

You will need.			
Medium Strength Thread Locker	3/16 Drill Bit	3/8 Wrench	Phillips Screwdriver

**As with any restraint system, replace after severe use, or after 3 years of use.**

WARNING: THIS ARTICLE IS SOLD WITHOUT WARRANTY, EXPRESSED OR IMPLIED. NO WARRANTY OR REPRESENTATION IS MADE AS TO THIS PRODUCTS ABILITY TO PROTECT THE USER FROM ANY INJURY OR DEATH. THE USER ASSUMES THAT RISK.

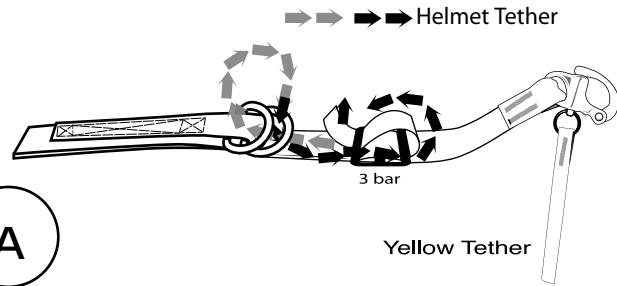
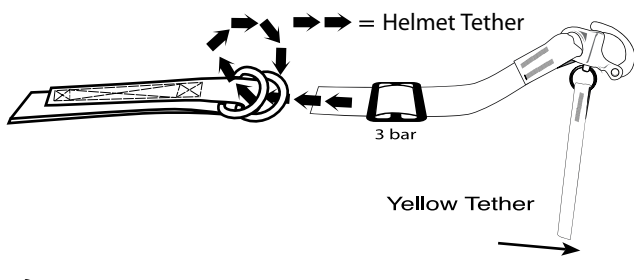

A

### A) Helmet Tethers

Lace the helmet tethers provided, to the upper D-rings on the top of the Vertical straps on the Hutchens Device™. Per Diagram A.

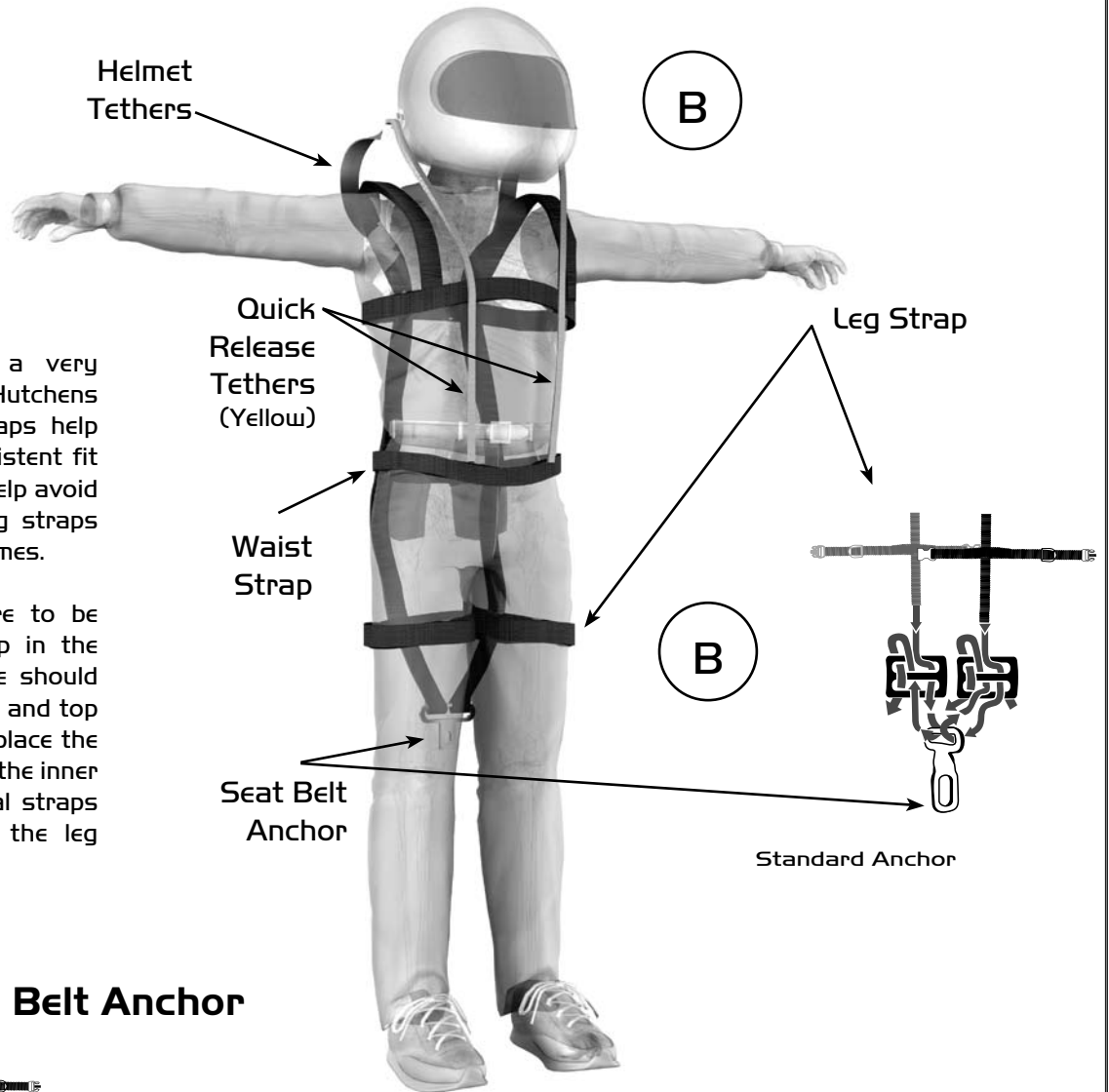

### B) Leg Straps (Optional)

The leg straps are a very important part of the Hutchens Device™. The leg straps help provide provide a consistent fit of the device and can help avoid serious injury. The leg straps should be worn at all times.

The vertical straps are to be laced through the loop in the leg straps. The buckle should be located to the inside and top of the thigh. This will place the loop in the leg strap on the inner thigh. Feed the vertical straps through the loops in the leg straps. See diagram B.

### Optional Seat Belt Anchor

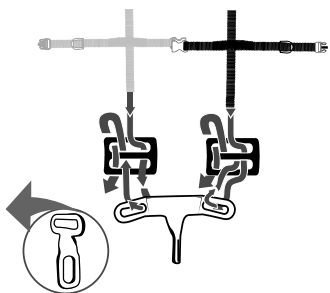

The "NEW T-Bar" will fit on any Latch & Link system currently on the market. It will spread out the vertical straps as they come through the groin area.

**As with any restraint system, replace after severe use, or after 3 years of use.**

WARNING: THIS ARTICLE IS SOLD WITHOUT WARRANTY, EXPRESSED OR IMPLIED. NO WARRANTY OR REPRESENTATION IS MADE AS TO THIS PRODUCTS ABILITY TO PROTECT THE USER FROM ANY INJURY OR DEATH. THE USER ASSUMES THAT RISK.

## Fitting the Device to the Occupant:

1. Hold harness by the elastic shoulder straps. Insert right arm through shoulder elastic and chest strap with helmet tethers and D-rings to the back of the occupant. Insert left arm through opposite shoulder elastic. Lock chest strap buckle and adjust to size.
2. Lock waist strap and adjust to size.
3. With the helmet tethers positioned on shoulders, buckle the leg straps if used. Enter and sit down into the driver's seat. Keep the anchor in front of you while sitting.
4. Adjust the seat belt anchor between the legs by pulling webbing through the webbing slide adjuster and lower slot of the seat belt anchor. Secure seat belt

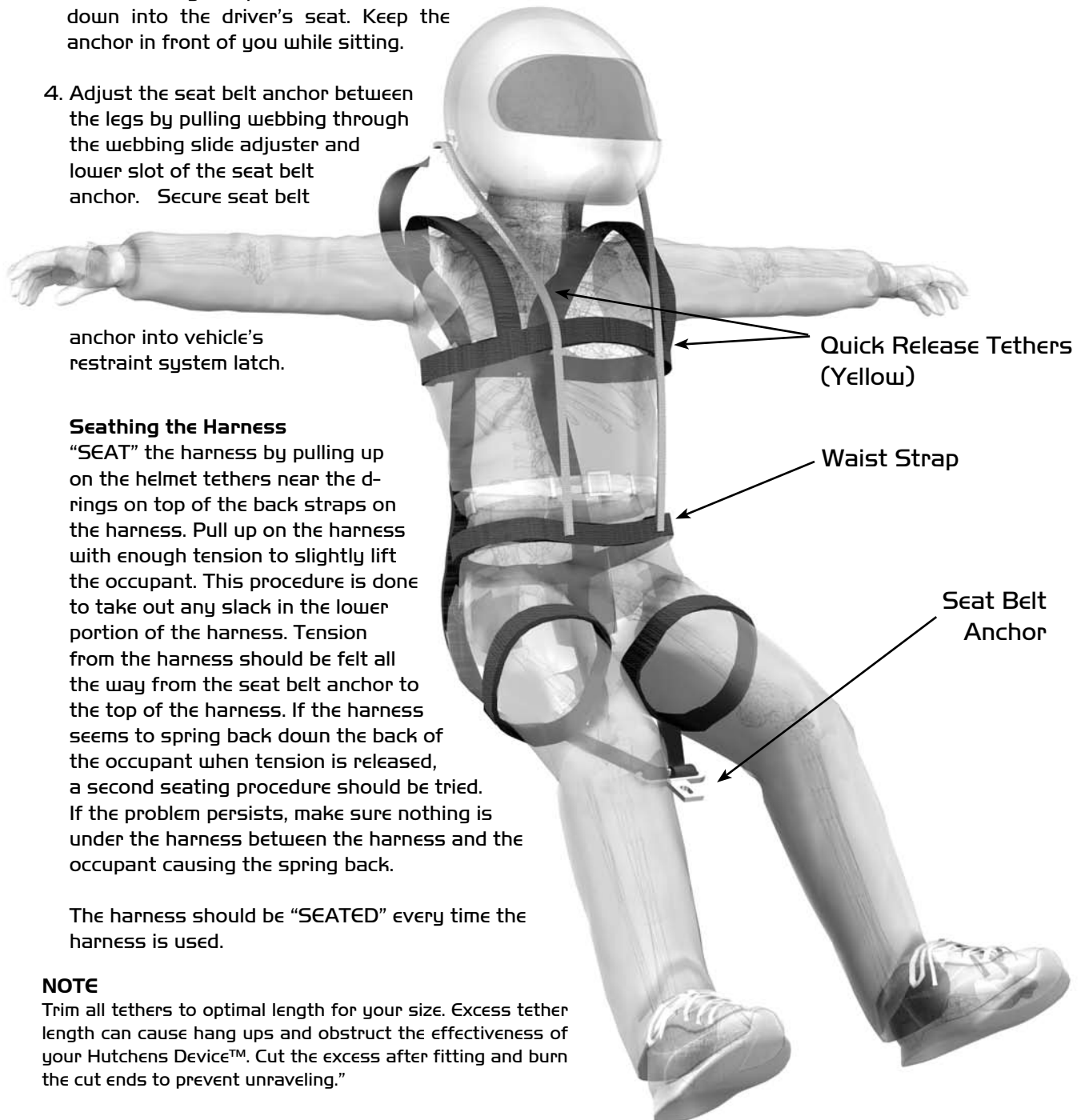

anchor into vehicle's restraint system latch.

Quick Release Tethers (Yellow)

Waist Strap

Seat Belt Anchor

### Seating the Harness

"SEAT" the harness by pulling up on the helmet tethers near the d-rings on top of the back straps on the harness. Pull up on the harness with enough tension to slightly lift the occupant. This procedure is done to take out any slack in the lower portion of the harness. Tension from the harness should be felt all the way from the seat belt anchor to the top of the harness. If the harness seems to spring back down the back of the occupant when tension is released, a second seating procedure should be tried. If the problem persists, make sure nothing is under the harness between the harness and the occupant causing the spring back.

The harness should be "SEATED" every time the harness is used.

### NOTE

Trim all tethers to optimal length for your size. Excess tether length can cause hang ups and obstruct the effectiveness of your Hutchens Device™. Cut the excess after fitting and burn the cut ends to prevent unraveling."

**As with any restraint system, replace after severe use, or after 3 years of use.**

WARNING: THIS ARTICLE IS SOLD WITHOUT WARRANTY, EXPRESSED OR IMPLIED. NO WARRANTY OR REPRESENTATION IS MADE AS TO THIS PRODUCTS ABILITY TO PROTECT THE USER FROM ANY INJURY OR DEATH. THE USER ASSUMES THAT RISK.

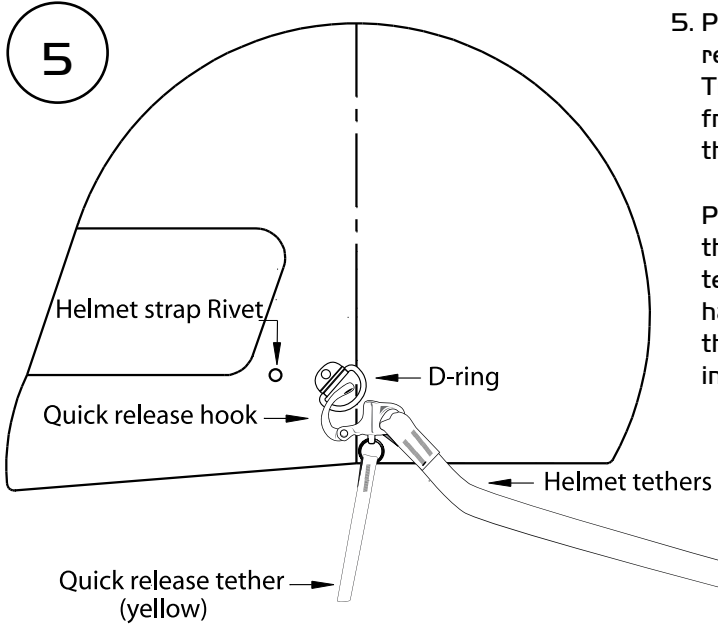

5. Pull the Quick Release bail to release. Attach the Quick release hook to the helmet D-rings on the helmet. The Quick releases should be routed into the D-ring from the “outside of the D-ring” to the inside, with the Quick Release tether pointed down on each side.

Position the Shoulder Harnesses to the OUTSIDE of the vertical straps and the helmet tethers. The helmet tethers need to be on the inside of the shoulder belt harnesses to provide a straight load path and to insure the harness does not get caught up in the shoulder belts in case a quick egress is needed. See Diagram 5B.

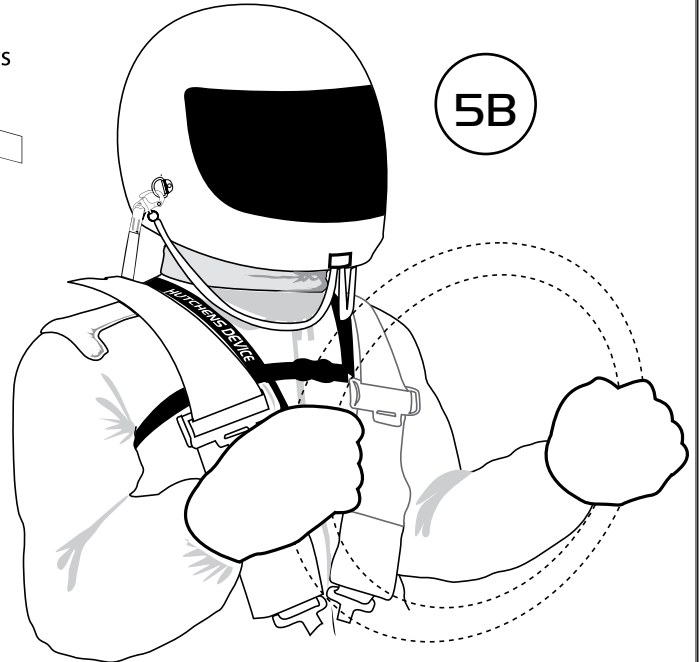

**NOTE:** The best placement for the release tethers is taped or attached to the chin of the helmet.

### 6. Adjustments of the Helmet Tethers

Adjustment of the helmet tethers is critical to the proper function of the harness. The highest neck tension occurs very early in an accident. Therefore: the initial tension on the harness is directly related to the effectiveness of the system.

The harness should be adjusted to allow a MAXIMUM of 1/2” FORWARD movement before tension is felt in the harness system. This should allow approximately 20 degrees of side to side movement. (extra mirrors, where allowed, are a good idea to help eliminate blind spots.)

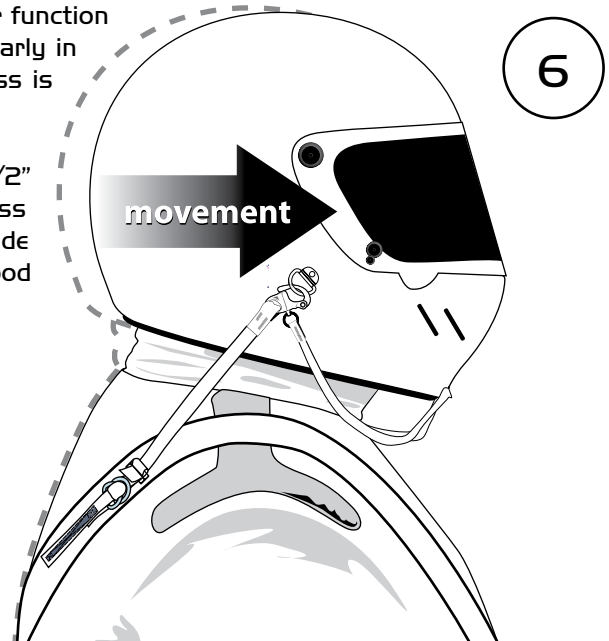

**As with any restraint system, replace after severe use, or after 3 years of use.**

WARNING: THIS ARTICLE IS SOLD WITHOUT WARRANTY, EXPRESSED OR IMPLIED. NO WARRANTY OR REPRESENTATION IS MADE AS TO THIS PRODUCTS ABILITY TO PROTECT THE USER FROM ANY INJURY OR DEATH. THE USER ASSUMES THAT RISK.

7. Each time the harness is worn, check to insure all latches are secure. "SEAT" the harness, by pulling up on the helmet tethers before attaching the quick release to the helmet. This will take out unwanted slack in the system.

Minor adjustments may be necessary to properly tension the harness each time the system is worn.

**Some of the factors that can influence the harness fit are:**

- 1) Driving suit fit – a loose fitting driving suit will allow the harness to better fit the occupant. It will also allow the fire suit to increase it's effectiveness in a fire by providing air gaps.
- 2) The seat and seat belt tension can also change the routing distance and thus require harness adjustment.

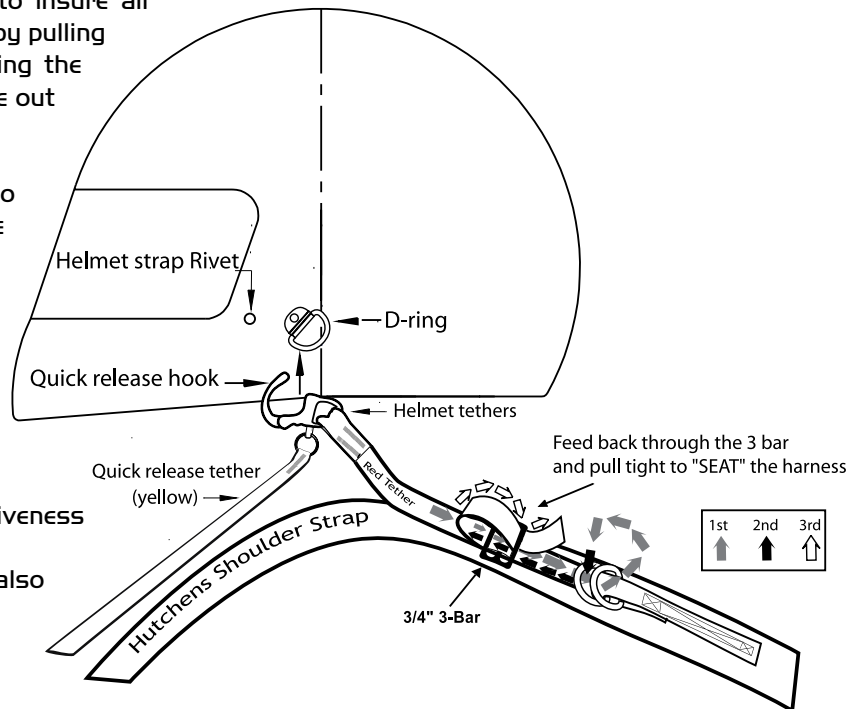

## SAFETY SYSTEM

A Safety Solutions head and neck restraint, Huchens Device, is only one part of a good safety system for any race car. It is very important to make sure all of your safety equipment is in top shape and interacts well with the other components of your safety system.

A Hutchens Device has been shown to be most effective in a system with properly mounted seat belts and a G-point sub-belt system. The G-point has been shown to better control the occupant's pelvis earlier in the event. By securing the pelvis earlier in the event, the upper torso and head loads will be reduced.

A rib support seat with shoulders and a quality head rest has also shown to be beneficial to the effectiveness of the harness system. The seat should be securely mounted and have a ramp-up to the front of the seat to help reduce the occupant motion in a frontal or angular frontal impact. The rib support seat will help slow down the upper torso and cause the body to curl around it. This motion will increase tension on the vertical straps of the harness.

A quality headrest and nets will help the occupant stay inside of the safety system and will help guide the head during the event. Contact with the steering wheel in a stock car is very likely. For this reason, a wheel with thin or relieved spokes and a column that can stroke can help control the head motion in an impact. This is the same principal that is used in your passenger car.

Head and neck restraint devices are most effective in angular frontal and frontal crashes. They become less effective in side and rear impacts. The occupant needs to rely on the other parts of the safety system in these types of impacts. The seat and headrest is the main restraint in side and rearward impacts.

**As with any restraint system, replace after severe use, or after 3 years of use.**

WARNING: THIS ARTICLE IS SOLD WITHOUT WARRANTY, EXPRESSED OR IMPLIED. NO WARRANTY OR REPRESENTATION IS MADE AS TO THIS PRODUCTS ABILITY TO PROTECT THE USER FROM ANY INJURY OR DEATH. THE USER ASSUMES THAT RISK.

# Attachment for a Camlock belt system

## Option 1:

Easiest - If using a 5-point or 6-point system with camlock.

Insert left lap belt tongue through the tongue on the Hutchens Device™ then into buckle.

(This configuration has been tested with no issues.)

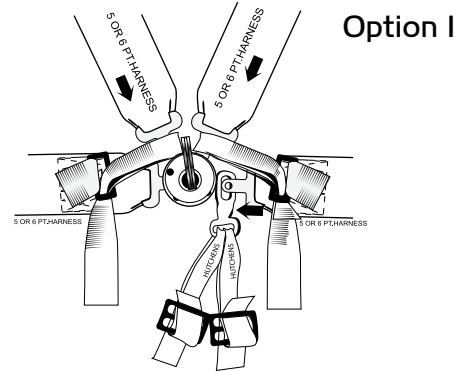

## Option 2:

For use when not using a 6-point or the opening in the bottom of the buckle.

Requires the use of a Camlock tongue that can be webbed in place of the current tongue. The tongue is available from Simpson ( upper torso Tongue for Camlock) or from BSR Products. ( also known as a 6-point anchor. )

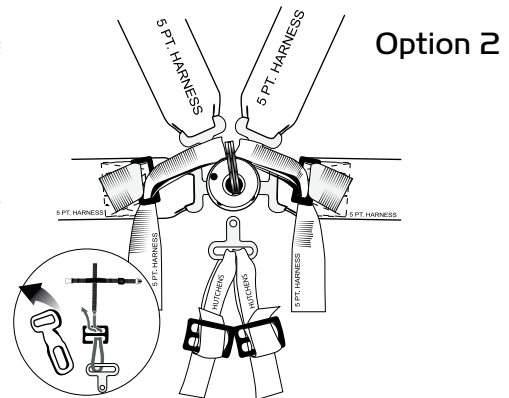

## Option 3:

For use with the D-ring 6-point.

If the customer is using a Formula style belt with D-rings on the lap belts. The harness can be modified by unlacing the tongue on the harness and making a loop at each end of the vertical straps. The loops then follow the 6-points through the D-rings on the lap belts and up to the upper torso tongues to lock into the belt system.

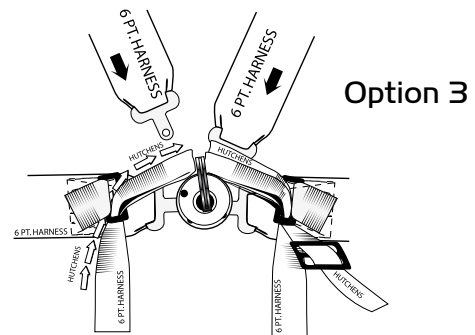

**As with any restraint system, replace after severe use, or after 3 years of use.**

WARNING: THIS ARTICLE IS SOLD WITHOUT WARRANTY, EXPRESSED OR IMPLIED. NO WARRANTY OR REPRESENTATION IS MADE AS TO THIS PRODUCTS ABILITY TO PROTECT THE USER FROM ANY INJURY OR DEATH. THE USER ASSUMES THAT RISK.



**1-800-731-4404**

**[www.hutchensdevice.com](http://www.hutchensdevice.com)**

**As with any restraint system, replace after severe use, or after 3 years of use.**

WARNING: THIS ARTICLE IS SOLD WITHOUT WARRANTY, EXPRESSED OR IMPLIED. NO WARRANTY OR REPRESENTATION IS MADE AS TO THIS PRODUCTS ABILITY TO PROTECT THE USER FROM ANY INJURY OR DEATH. THE USER ASSUMES THAT RISK.